



Politecnico
di Torino



e-Lite



Database access and JDBC

Tecniche di Programmazione – A.A. 2021/2022



Outline

1. Introduction to JDBC
2. Accessing a database: practical steps
3. Prepared statements
4. Design patterns (DAO)
5. Object-Relational Mapping
6. Connection pooling

<http://dilbert.com/strips/comic/1995-11-17/>



Goals

- ▶ **Enable Java applications to access data stored in Relational Data Bases**
 - ▶ Query existing data
 - ▶ Modify existing data
 - ▶ Insert new data
- ▶ **Data can be used by**
 - ▶ The algorithms running in the application
 - ▶ The user, through the user interface

JDBC

- ▶ Standard library for accessing relational databases
- ▶ Compatible with most/all different databases
- ▶ JDBC : Java Database Connectivity
- ▶ Defined in package **java.sql** and **javax.sql**
- ▶ Documentation:
 - ▶ Doc Index:
<http://docs.oracle.com/javase/8/docs/technotes/guides/jdbc/index.html>
 - ▶ <https://www.oracle.com/technetwork/java/javase/tech/index-jsp-136101.html>
 - ▶ JDBC Overview: <http://www.oracle.com/technetwork/java/overview-141217.html>
 - ▶ Tutorial
<http://docs.oracle.com/javase/tutorial/jdbc/basics/index.html>

JDBC scope

- ▶ **Standardizes**
 - ▶ Mechanism for connecting to DBMSs
 - ▶ Syntax for sending queries
 - ▶ Structure representing the results
- ▶ **Does not standardize**
 - ▶ SQL syntax: dialects, variants, extensions, ...

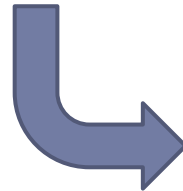

<http://troels.arvin.dk/db/rdbms/>

Architecture

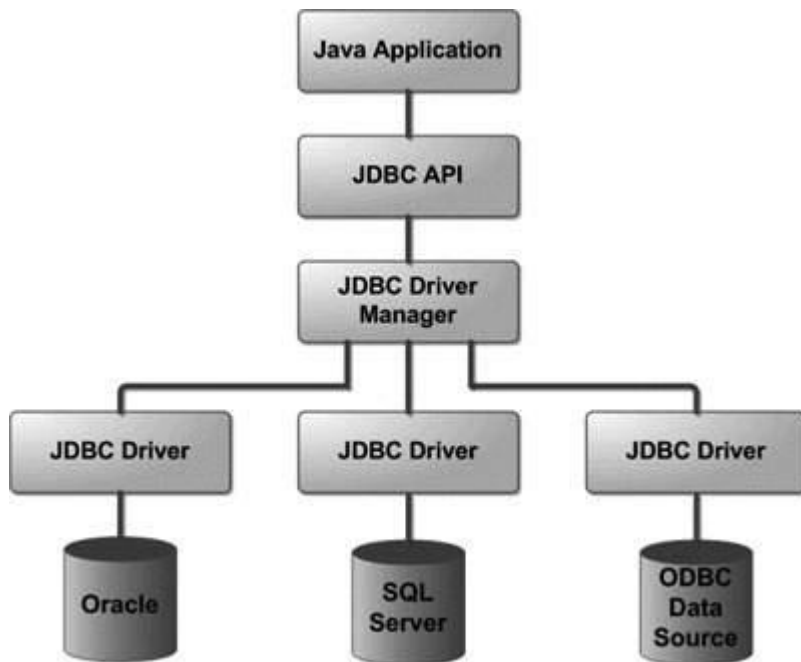

- ▶ Java application (in our case, JavaFX)
- ▶ JDBC Driver Manager (or *Data Source – later on*)
 - ▶ For loading the JDBC Driver
- ▶ JDBC Driver
 - ▶ From DBMS vendor
- ▶ DBMS
 - ▶ In our case, MySQL or MariaDB

Basic steps

1. Define the connection URL
2. Establish the connection
3. Create a statement object
4. Execute a query or update
5. Process the results
6. Close the connection

JDBC Driver

- ▶ A Driver is a DMBS-vendor provided class, that must be available to the Java application
 - ▶ Should reside in the project's libraries
 - ▶ Should be accessible in the project's Class Path
- ▶ The application usually doesn't know the driver class name until run-time (to ease the migration to other DMBSs)
- ▶ Needs to find and load the class at run-time

MySQL JDBC driver

- ▶ MySQL Connector/J
 - ▶ <http://dev.mysql.com/downloads/connector/j/>
 - ▶ Provides mysql-connector-java-[version]-bin.jar
 - ▶ Copy or link into project libraries
- ▶ The driver is in class
 - ▶ `com.mysql.jdbc.Driver`
 - ▶ ...but we don't need (want) to know it!
- ▶ Documentation: <https://dev.mysql.com/doc/connector-j/8.0/en/>

MariaDB JDBC driver

- ▶ MariaDB Connector/J
 - ▶ <https://mariadb.com/kb/en/mariadb-connector-j/>
 - ▶ Provides mariadb-java-client-2.6.0.jar
- ▶ Provides the class `org.mariadb.jdbc.Driver`
- ▶ Responds to JDBC URLs
 - ▶ `jdbc:mariadb://....`
 - ▶ `jdbc:mysql://....`

TdP Maven Archetype

- ▶ The Maven Archetype for TdP already includes the MariaDB JDBC Driver... you don't need to download, install nor configure anything



1. Define the connection URL

- ▶ **The Driver Manager needs some information to connect to the DBMS**
 - ▶ The database type (to call the proper Driver, that we already loaded in the first step)
 - ▶ The server address
 - ▶ Authentication information (user/pass)
 - ▶ Database / schema to connect to
- ▶ **All these parameters are encoded into a string**
 - ▶ The exact format depends on the Driver vendor

MySQL Connection URL format

- ▶ `jdbc:mysql://[host:port],[host:port].../[database][?propertyName1]=[propertyValue1][&propertyName2]=[propertyValue2]...`
- ▶ `jdbc:mysql://` or `jdbc:mariadb://`
- ▶ `host:port` (usually: `localhost`)
- ▶ `/database`
- ▶ `?user=username`
- ▶ `&password=pppppppp` (omit for XAMPP)

<https://dev.mysql.com/doc/connector-j/8.0/en/connector-j-reference-configuration-properties.html>

2. Establish the connection

- ▶ Use `DriverManager.getConnection`
 - ▶ Uses the appropriate driver according to the connection URL
 - ▶ Returns a `Connection` object
- ▶ `Connection connection = DriverManager.getConnection(URLString)`
- ▶ Contacts DBMS, validates user and selects the database
- ▶ On the `Connection` object subsequent commands will execute queries

Example

```
import java.sql.Connection;
import java.sql.DriverManager;
import java.sql.SQLException;

    try {
        Connection conn = DriverManager.getConnection(
"jdbc:mysql://localhost/test?user=monty&password=secret");

        // Do something with the Connection
        ....

    } catch (SQLException ex) {
        // handle any errors
        System.out.println("SQLException: " + ex.getMessage());
        System.out.println("SQLState: " + ex.getSQLState());
        System.out.println("VendorError: " + ex.getErrorCode());
    }
```

Class diagram

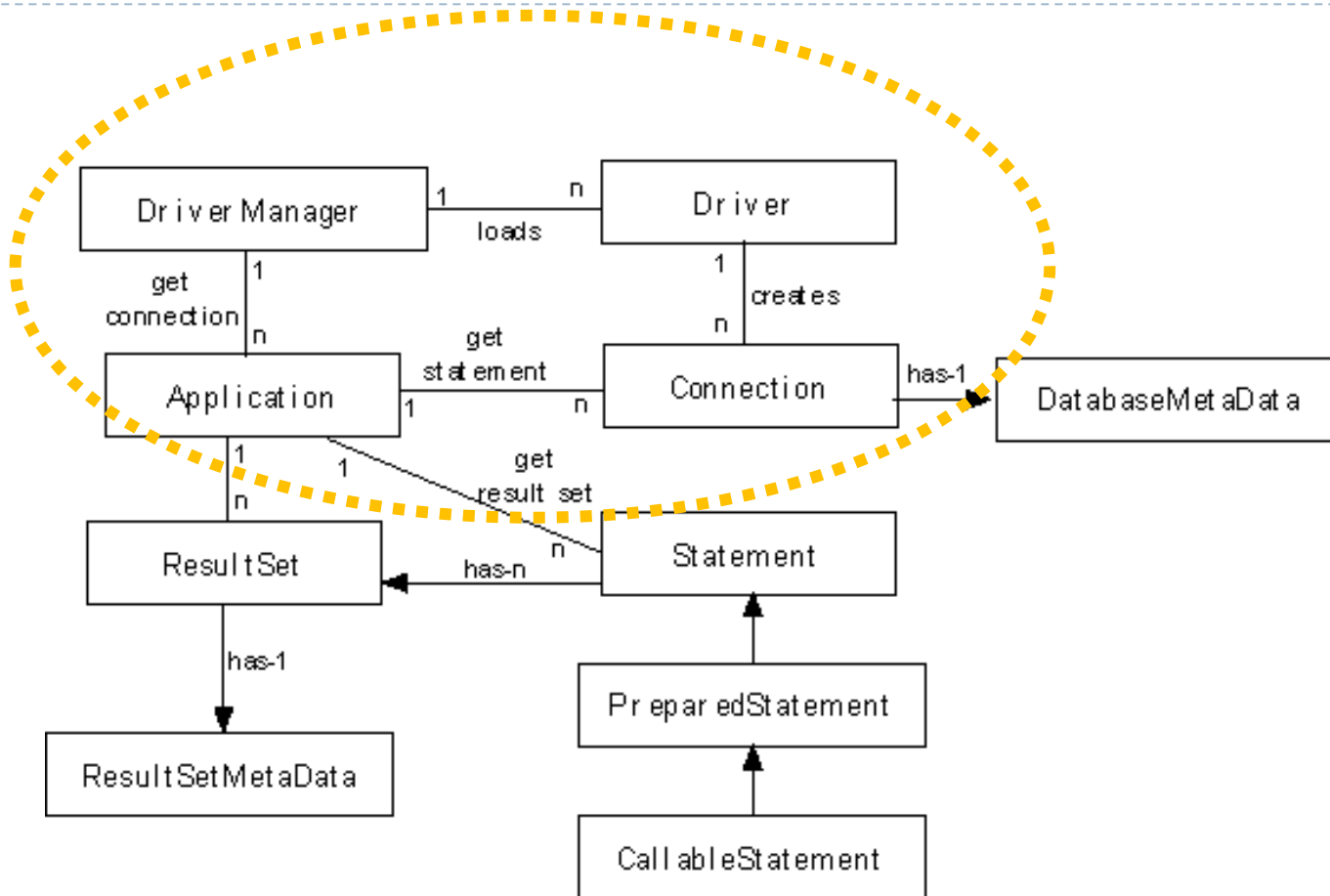



6. Close the connection

- ▶ When no additional queries are needed, close the connection to the database:
 - ▶ `connection.close()` ;

3. Create a Statement object

- ▶ `Statement statement = connection.createStatement() ;`
- ▶ Creates a Statement object for sending SQL statements to the database.
- ▶ SQL statements without parameters are normally executed using Statement objects.

- ▶ For efficiency and security reasons, we will always use a `PreparedStatement` object (see later...).

4. Execute a query

- ▶ Use the `executeQuery` method of the `Statement` class
 - ▶ `ResultSet executeQuery(String sql)`
 - ▶ `sql` contains a `SELECT` statement
- ▶ Returns a `ResultSet` object, that will be used to retrieve the query results

Class diagram

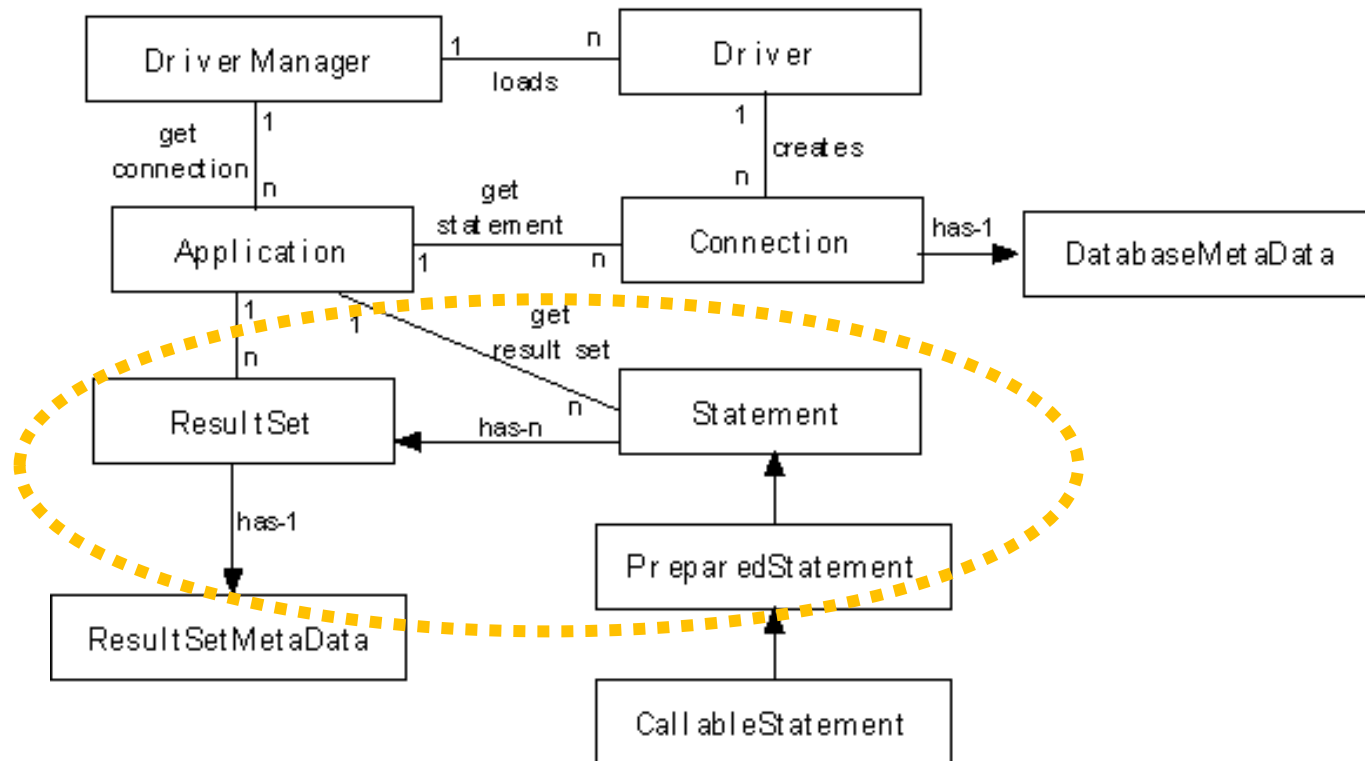

Other execute methods

- ▶ `int executeUpdate(String sql)`
 - ▶ For INSERT, UPDATE, or DELETE statements
 - ▶ For other SQL statements that don't return a resultset (e.g., CREATE TABLE)
 - ▶ returns either the row count for INSERT, UPDATE or DELETE statements, or 0 for SQL statements that return nothing

- ▶ `boolean execute(String sql)`
 - ▶ For general SQL statements

Example

```
String query = "SELECT id, name FROM user" ;  
ResultSet resultSet =  
statement.executeQuery(query) ;
```

Parametric queries

- ▶ SQL queries may depend on user input data
- ▶ Example: find item whose code is specified by the user
- ▶ Method 1: String interpolation (with concatenation or `String.format`)
 - ▶ String query =
"SELECT * FROM items
WHERE code='"+userCode+"'" ;

Parametric queries

- ▶ SQL queries may depend on user input data
- ▶ Example: find item whose code is specified by the user
- ▶ Method 1: String interpolation (with concatenation or `String.format`)
 - ▶ String query =
 `"SELECT * FROM items
 WHERE code='"+userCode+"'" ;`
- ▶ Method 2: use Prepared Statements
 - ▶ Always preferable
 - ▶ Always
 - ▶ [See later...](#)



5. Process the result

- ▶ The ResultSet object *implements a “cursor”* over the query results
 - ▶ Data are available a row at a time
 - ▶ Method `ResultSet.next()` goes to the next row
 - ▶ The column values (for the selected row) are available through **getXXX** methods
 - ▶ `getInt`, `getString`, `getBoolean`, `getDate`, `getDouble`, ...
 - ▶ Data types are converted from SQL types to Java types

Full list at

<https://docs.oracle.com/javase/7/docs/api/java/sql/ResultSet.html>

Cursor

Cursor default position (before first record) →

100	<u>S N Rao</u>	5500.50	1 st Record
101	<u>Jyostna</u>	6500.50	2 nd Record
102	<u>Jyothi</u>	7550.50	3 rd Record

Cursor on first record →

100	<u>S N Rao</u>	5500.50	1 st Record
101	<u>Jyostna</u>	6500.50	2 nd Record
102	<u>Jyothi</u>	7550.50	3 rd Record

Cursor position after last record →

100	<u>S N Rao</u>	5500.50	1 st Record
101	<u>Jyostna</u>	6500.50	2 nd Record
102	<u>Jyothi</u>	7550.50	3 rd Record

ResultSet.getXXX methods

- ▶ **XXX** is the desired datatype
 - ▶ Must be compatible with the column type
 - ▶ String is almost always acceptable
- ▶ **Two versions**
 - ▶ `getXXX(int columnIndex)`
 - ▶ number of column to retrieve (starting from 1 – *beware!*)
 - ▶ `getXXX(String columnName)`
 - ▶ name of column to retrieve
 - ▶ Always preferred

ResultSet navigation methods

- ▶ `boolean next()`
 - ▶ Moves the cursor down one row from its current position.
 - ▶ A `ResultSet` cursor is initially positioned **before the first row**:
 - ▶ the first call to the method `next` makes the first row the current row
 - ▶ the second call makes the second row the current row, ...

Other navigation methods (1 / 2)

- ▶ **Query cursor position**
 - ▶ `boolean isFirst()`
 - ▶ `boolean isLast()`
 - ▶ `boolean isBeforeFirst()`
 - ▶ `boolean isAfterLast()`

Other navigation methods (2/2)

▶ Move cursor

- ▶ `void beforeFirst()`
- ▶ `void afterLast()`
- ▶ `boolean first()`
- ▶ `boolean last()`
- ▶ `boolean absolute(int row)`
- ▶ `boolean relative(int rows) // positive or negative offset`
- ▶ `boolean previous()`

Example

```
while( resultSet.next() )
{
    out.println(
        resultSet.getInt("ID") + " - " +
        resultSet.getString("name") ) ;
}
```

Datatype conversions (MySQL)

These MySQL Data Types	Can always be converted to these Java types
CHAR, VARCHAR, BLOB, TEXT, ENUM, and SET	<code>java.lang.String</code> , <code>java.io.InputStream</code> , <code>java.io.Reader</code> , <code>java.sql.Blob</code> , <code>java.sql.Clob</code>
FLOAT, REAL, DOUBLE PRECISION, NUMERIC, DECIMAL, TINYINT, SMALLINT, MEDIUMINT, INTEGER, BIGINT	<code>java.lang.String</code> , <code>java.lang.Short</code> , <code>java.lang.Integer</code> , <code>java.lang.Long</code> , <code>java.lang.Double</code> , <code>java.math.BigDecimal</code>
DATE, TIME, DATETIME, TIMESTAMP	<code>java.lang.String</code> , <code>java.sql.Date</code> , <code>java.sql.Timestamp</code>

Datatype conversions

	TINYINT	SMALLINT	INTEGER	BIGINT	REAL	FLOAT	DOUBLE	DECIMAL	NUMERIC	BIT	CHAR	VARCHAR	LONGVARCHAR	BINARY	VARBINARY	LONGVARBINARY	DATE	TIME	TIMESTAMP	CLOB	BLOB	ARRAY	REF	STRUCT	JAVA OBJECT
getBytes	X	x	x	x	x	x	x	x	x	x	x	x	x												
getShort	x	X	x	x	x	x	x	x	x	x	x	x	x												
getInt	x	x	X	x	x	x	x	x	x	x	x	x	x												
getLong	x	x	x	X	x	x	x	x	x	x	x	x	x												
getFloat	x	x	x	x	X	x	x	x	x	x	x	x	x												
getDouble	x	x	x	x	x	X	X	x	x	x	x	x	x												
getBigDecimal	x	x	x	x	x	x	X	X	x	x	x	x	x												
getBoolean	x	x	x	x	x	x	x	x	x	X	x	x	x												
getString	x	x	x	x	x	x	x	x	x	x	X	X	x	x	x	x	x	x	x						
getBytes														X	X	x									
getDate											x	x	x				X		x						
getTime											x	x	x					X	x						
getTimestamp											x	x	x				x	x	X						
getAsciiStream											x	x	X	x	x	x									
getUnicodeStream											x	x	X	x	x	x									
getBinaryStream														x	x	X									
getClob																				X					
getBlob																					X				
getArray																						X			
getRef																							X		
getCharacterStream											x	x	X	x	x	x									
getObject	x	x	x	x	x	x	x	x	x	x	x	x	x	x	x	x	x	x	x	x	x	x	x	X	X

Table 5.1: Use of ResultSet.getXXX Methods to Retrieve JDBC Types

6. Close the connection

- ▶ **Additional queries may be done on the same connection.**
 - ▶ Each returns a different `ResultSet` object, unless you re-use it
 - ▶ When no longer needed, `ResultSet` resources can be freed by 'closing' it: `resultSet.close()`
- ▶ **When no additional queries are needed, close the connection to the database:**
 - ▶ `connection.close() ;`

What's wrong with statements?

- ▶ `String user = txtUserName.getText() ; // JavaFX`
- ▶ `String sql = "select * from users where username='" + user + "'" ;`
- ▶ **Problems:**
 - ▶ Security
 - ▶ Performance

Security risk

- ▶ SQL injection – syntax errors or privilege escalation

- ▶ Example

- ▶ Username : `' ; delete * from users ; --`



```
select * from users where  
username=''; delete * from  
users ; -- '
```

- ▶ **Must** detect or escape all dangerous characters!
 - ▶ Will **never** be perfect...
- ▶ **Never** trust user-entered data. Never. Not once. Really.

SQL injection attempt 😊



SQL injection attempt 😊

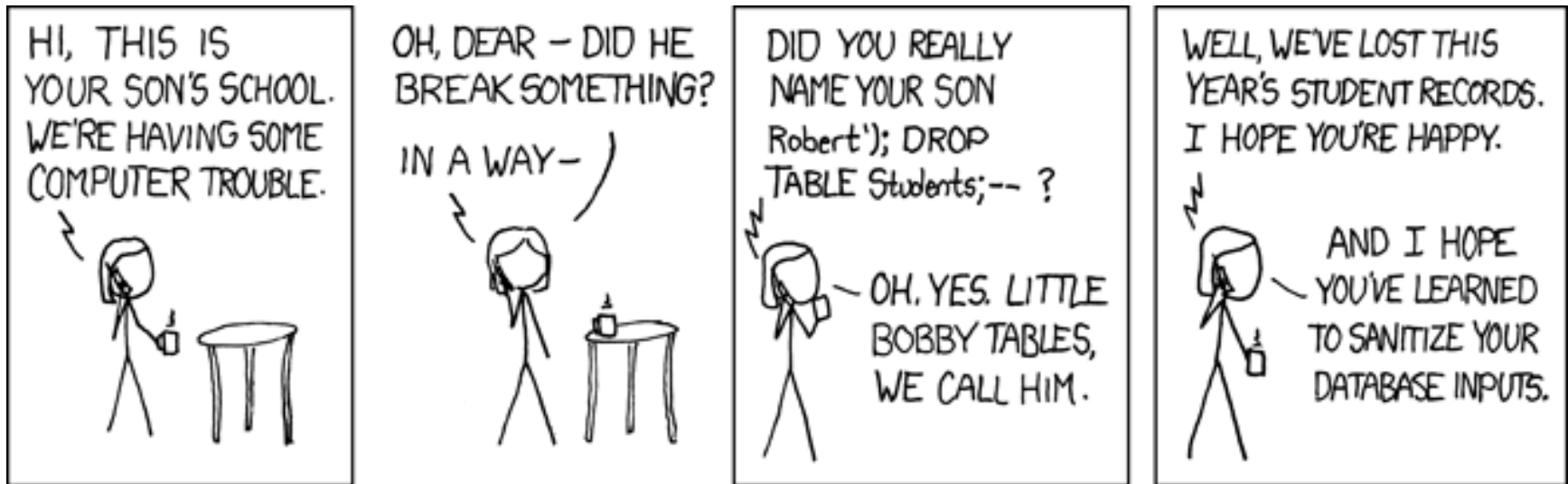

<http://xkcd.com/327/>

Performance limitations

- ▶ **Performance limit**
 - ▶ Query must be re-parsed and re-optimized every time
 - ▶ Complex queries require significant set-up overhead
- ▶ **When the same query is repeated (even with different data), parsing and optimization wastes CPU time in the DBMS server**
 - ▶ Increased response-time latency
 - ▶ Decreased scalability of the system

Prepared statements

- ▶ Separate statement **creation** from statement **execution**
 - ▶ At creation time: define SQL syntax (**template**), with placeholders for variable quantities (**parameters**)
 - ▶ At execution time: define actual quantities for placeholders (**parameter values**), and run the statement
- ▶ Prepared statements can be re-run many times
- ▶ Parameter values are automatically
 - ▶ Converted according to their Java type
 - ▶ Escaped, if they contain dangerous characters
 - ▶ Handle non-character data (serialization)

Example

```
Connection connection =  
DriverManager.getConnection(url, username, password);
```

```
String template =  
"UPDATE music SET price = ? WHERE id = ?";
```

```
PreparedStatement statement =  
connection.prepareStatement(template);
```

```
float[] newPrices = getNewPrices();  
int[] recordingIDs = getIDs();
```

```
for(int i=0; i<recordingIDs.length; i++) {  
    statement.setFloat(1, newPrices[i]); // Price  
    statement.setInt(2, recordingIDs[i]); // ID  
  
    statement.execute();  
}
```

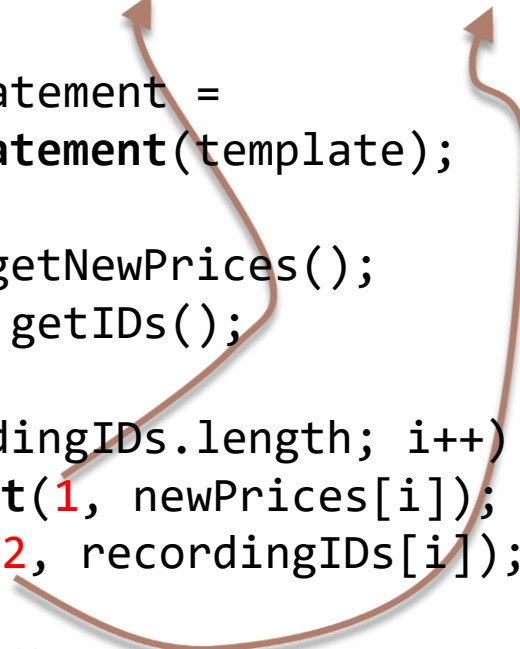

Prepared statements

- ▶ **Easier to write**
 - ▶ Data type conversion done by JDBC library
- ▶ **Secure (no SQL injection possible)**
 - ▶ Quoting is done by JDBC library
- ▶ **More efficient**
 - ▶ Query re-use
 - ▶ Parameter values sent in binary form
- ▶ **The bottom line: *Always use prepared statements.***

Callable statements

- ▶ Many DBMSs allow defining “stored procedures”, directly defined at the DB level
- ▶ Stored procedures are SQL queries (with parameters), or sequences of queries
 - ▶ Language for defining stored procedures is DBMS-dependent: not portable!
- ▶ MySQL: <http://dev.mysql.com/doc/refman/5.5/en/stored-programs-views.html> (chapter 18)
- ▶ Calling stored procedures: use CallableStatement in JDBC
 - ▶ Example: <http://dev.mysql.com/doc/refman/5.5/en/connector-j-usagenotes-basic.html#connector-j-examples-stored-procedure>



Design patterns (DAO)

Database access and JDBC

Problems

- ▶ Database code involves a lot of «specific» knowledge
 - ▶ Connection parameters
 - ▶ SQL commands
 - ▶ The structure of the database
- ▶ Bad practice to «mix» this low-level information with main application code
 - ▶ Reduces portability and maintainability
 - ▶ Creates more complex code
 - ▶ Breaks the «one-class one-task» assumption
- ▶ What is a better code organization?

Goals

- ▶ Encapsulate DataBase access into separate classes, distinct from application ones
 - ▶ All other classes should be shielded from DB details
- ▶ DataBase access should be independent from application needs
 - ▶ Potentially reusable in different parts of the application
- ▶ Develop a reusable development patterns that can be easily applied to different situations

Data Access Object (DAO) – 1 / 2

- ▶ **«Client» classes:**
 - ▶ Application code that needs to access the database
 - ▶ Ignorant of database details (connection, queries, schema, ...)
- ▶ **«DAO» classes:**
 - ▶ Encapsulate all database access code (JDBC)
 - ▶ The only ones that will ever contact the database
 - ▶ Ignorant of the goal of the Client

Data Access Object (DAO) – 2/2

- ▶ Low-level database classes: DriverManager, DataSource, ResultSet, etc
 - ▶ Used by DAO (only!) but invisible to Client
- ▶ «Transfer Object» (TO) or «Data Transfer Object» (DTO) classes
 - ▶ Contain data sent from Client to Dao and/or returned by DAO to Client
 - ▶ Represent the data model, as seen by the application
 - ▶ Usually POJO or JavaBean
 - ▶ Ignorant of DAO, ignorant of database, ignorant of Client

DAO class diagram

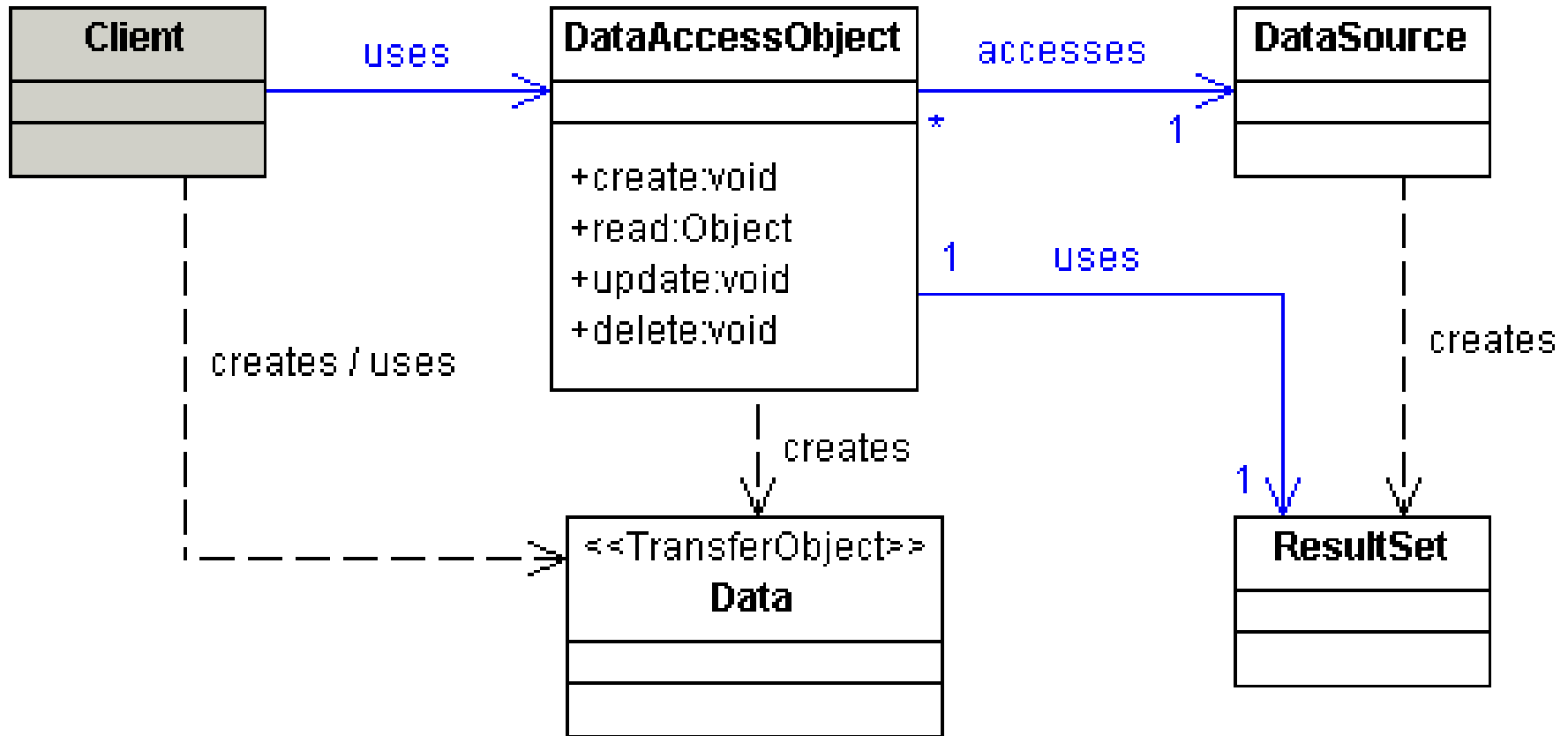

DAO Sequence diagram

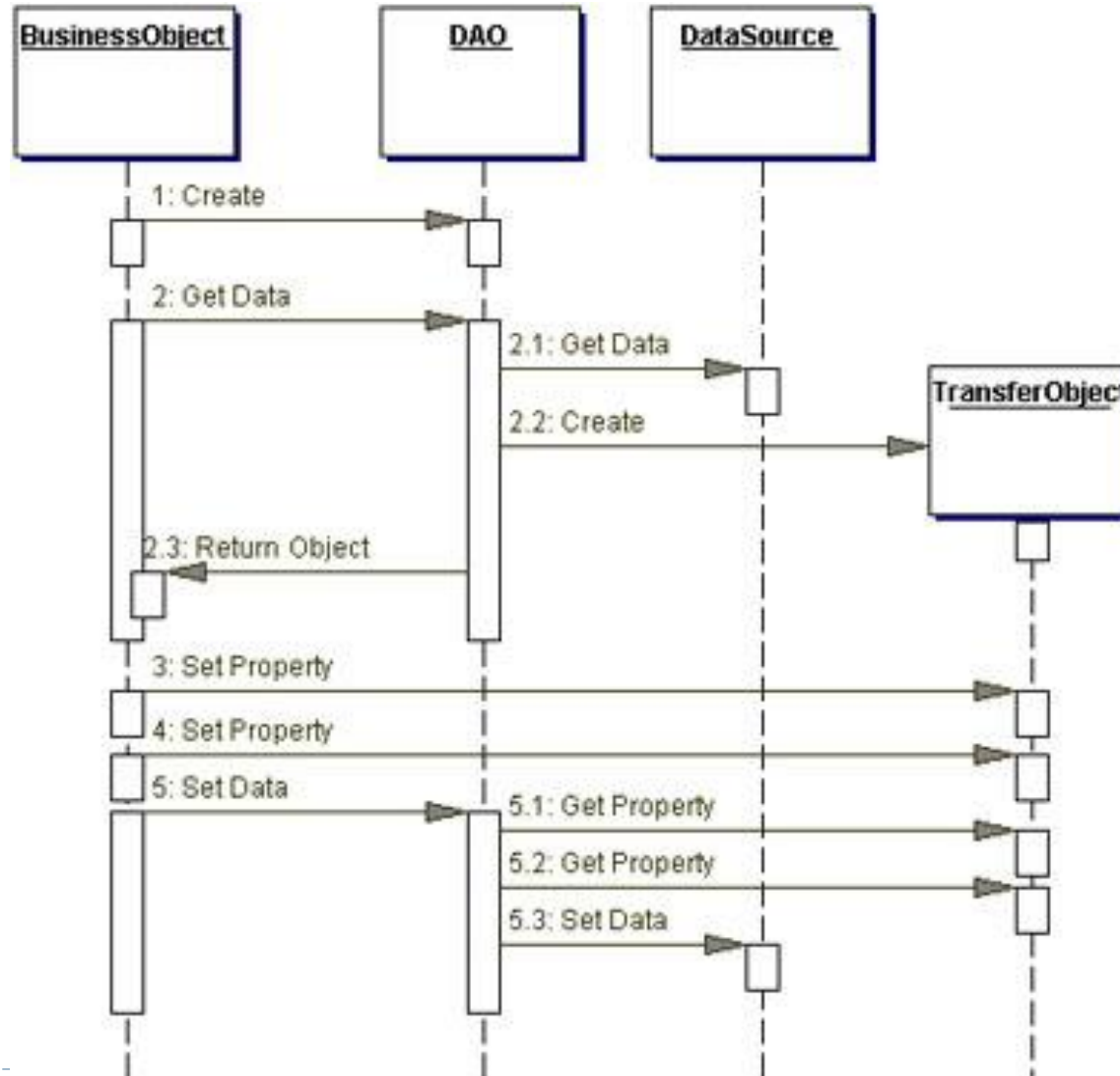

DAO design criteria

- ▶ **DAO has no state**
 - ▶ No instance variables (except Connection - maybe)
- ▶ **DAO manages one 'kind' of data**
 - ▶ Uses a small number of DTO classes and interacts with a small number of DB tables
 - ▶ If you need more, create many DAO classes
- ▶ **DAO offers CRUD methods**
 - ▶ Create, Read, Update, Delete
- ▶ **DAO may offer search methods**
 - ▶ Returning collections of DTO

public interface/class UserDao

- ▶ `public User find(Long id)`
 - ▶ `public boolean find(Long id, User u)`
 - ▶ `public boolean find(User u) // uses u.id`
- ▶ `public User find(String email, String password)`
- ▶ `public List<User> list()`
- ▶ `List<User> searchUserByName(String name)`
 - ▶ `List<User> searchByName(User u) ; // only u.name matters`

public interface/class UserDao

- ▶ `public void create(User user)`
 - ▶ `public Long create(User user) // returns new ID`
- ▶ `public void update(User user) // modify all except ID`
- ▶ `public void delete(User user)`
- ▶ `public boolean existEmail(String email)`
- ▶ `public void changePassword(User user)`



Object-Relational Mapping

Database access and JDBC

Mapping Tables to Objects

- ▶ Goal: guidelines for creating a set of Java Beans (DTO) to represent information stored in a relational database
- ▶ Goal: guidelines for designing the set of methods for DAO objects

Tables → Beans ORM rules

1. **Create one Java Bean per each main database entity**
 - ▶ Except tables used to store n:m relationships!
2. **Bean names should match table names**
 - ▶ In the singular form (Utente; User)
3. **The bean should have one private property for each column in the table, with matching names**
 - ▶ According to Java naming conventions (NUMERO_DATI -> numeroDati)
 - ▶ Match the data type
 - ▶ Except columns uses as foreign keys

Tables → Beans ORM rules

4. The main constructor must accept all the fields in the bean (one full data row)
 - ▶ Fields corresponding to foreign keys may not be present in the constructor (lazy object creation)
5. Add `get()/set()` methods for all properties
6. Define `equals` and `hashCode`, using the **exact** set of fields that compose the primary key of the table

Relationships, Foreign keys → Beans

- ▶ Define additional attributes in the Java Bean classes, for every relationship that we want to easily navigate in our application
 - ▶ Not necessarily **all** relationships!

Cardinality-1 relationship

- ▶ A relationship with cardinality **1** maps to an attribute referring to the corresponding Java object
 - ▶ not the PK value
- ▶ Use singular nouns.

1:1 relationship

STUDENTE

matricola (PK)

fk_persona

PERSONA

codice_fiscale (PK)

fk_studente

```
class Studente { private Persona persona ; }  
{ private String codice_fiscale ; }
```

```
class Persona { private Studente studente ; }  
{ private int matricola ; }
```

Cardinality-N relationship

- ▶ A relationship with cardinality **N** maps to an attribute containing a collection
 - ▶ The elements of the collection are corresponding Java objects (not PK values).
 - ▶ Use plural nouns.
 - ▶ The collection may be Set or List.
- ▶ The bean should have methods for reading (get, ...) and modifying (add, ...) the collection

1:N relationship

STUDENTE

matricola (PK)

fk_citta_residenza

CITTA

cod_citta (PK)

nome_citta

```
class Studente {  
    private Citta cittaResidenza ; }  
}
```

```
class Citta {  
    private Collection<Studente> studentiResidenti ; }  
}
```

1:N relationship

STUDENTE

matricola (PK)
fk_citta_residenza

CITTA

cod_citta (PK)
nome_citta

```
class Studente {  
    private Citta cittaResidenza ; }  
class Citta {  
    private Collection<Studente> studentiResidenti ; }
```

In SQL, there is no «explicit» Citta->Studente foreign key. The same FK is used to navigate the relationship in both directions.

In Java, both directions (if needed) must be represented explicitly.

N:M relationship

ARTICLE

id_article (PK)
Article data...

AUTHORSHIP

id_article (FK,PK*)
id_creator (FK,PK*)
id_authorship (PK#)

CREATOR

id_creator (PK)
Creator data...

```
class Article
{ private Collection<Creator> creators ; }
class Creator
{ private Collection<Article> articles ; }
```

N:M relationship

In SQL, there is an extra table just for the N:M relationship .

ARTICLE

AUTHORSHIP

CREATOR

id_article (PK)
Article data...

id_article (FK,PK*)
id_creator (FK,PK*)
id_authorship (PK#)

id_creator (PK)
Creator data

The PK may be an extra field (#) or a combination of the FKs (*)

```
class Article
```

```
{ private Collection<Creator> creators ; }
```

```
class Creator
```

```
{ private Collection<Article> articles ; }
```

The extra table is not represented.
The PK is not used.

Storing Keys vs Objects

```
private int  
idCittaResidenza ;
```

- ▶ Store the *value* of the foreign key
- ▶ Easy to retrieve
- ▶ Must call `CittaDao.readCitta(id)` to have the real data
- ▶ Tends to perform more queries

```
private Citta  
cittaResidenza ;
```

- ▶ Store a *fully initialized object*, corresponding to the matching foreign row
- ▶ Harder to retrieve (must use a Join or multiple/nested queries)
- ▶ Gets all data at the same time (eager loading)
- ▶ All data is readily available
- ▶ Maybe such data is not needed

Storing Keys vs Objects (3rd way)

```
private Citta  
cittaResidenza ; // Lazy
```

- ▶ Store a *partially* initialized object, with only the 'id' field set
- ▶ Easy to retrieve
- ▶ Must call `CittaDao.readCitta(id)` to have the real data (lazy loading)
- ▶ Loading details may be hidden behind getters

Identity problem

- ▶ It may happen that a single object gets retrieved many times, in different queries
 - ▶ Especially in the case of N:M relationships

```
List<Article> articles = dao.listArticle() ;  
for(Article a: articles) {  
    List<Creator> authors = dao.getCreatorsFor(a) ;  
    a.setCreators(authors) ;  
}
```

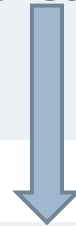

```
while(rs.next()) {  
    Creator c = new Creator( rs.getInt("id"), ... ) ;  
    result.add(c) ;  
}  
return result ;
```

Identity problem

- ▶ It may happen that a single object gets reused many times, in different queries
 - ▶ Especially in the case of N:M relationships

```
List<Article> articles = dao.listArticle();
for(Article a: articles) {
    List<Creator> authors = dao.getCreators(a);
    a.setCreators(authors);
}
```

```
while(rs.next()) {
    Creator c = new Creator( rs.getInt("id"), ... );
    result.add(c);
}
return result;
```

If the same Creator is author of many articles, a new object (with identical information) will be created, one per each article. A new, distinct object. They will all be `.equals()` to each other.

Identity problem

- ▶ It may happen that a single object gets retrieved many times, in different queries
 - ▶ Especially in the case of N:M relationships
- ▶ Different «identical» objects will be created (**new**)
 - ▶ They can be used interchangeably: `.equals()` and `.hashCode()` match
 - ▶ They waste memory space
 - ▶ They can't be compared for identity (`==` or `!=`)
- ▶ **Solution: avoid creating pseudo-identical objects**
 - ▶ Store all retrieved objects in a shared `Map<>`
 - ▶ Don't create an object if it's already in the map

Identity Map pattern

- ▶ Ensures that each object gets loaded only once, by keeping every loaded object in a map
- ▶ Looks up objects using the map when referring to them.

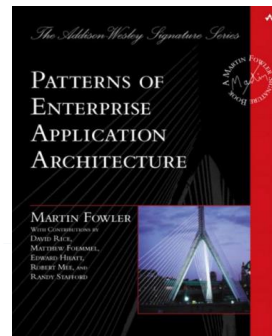
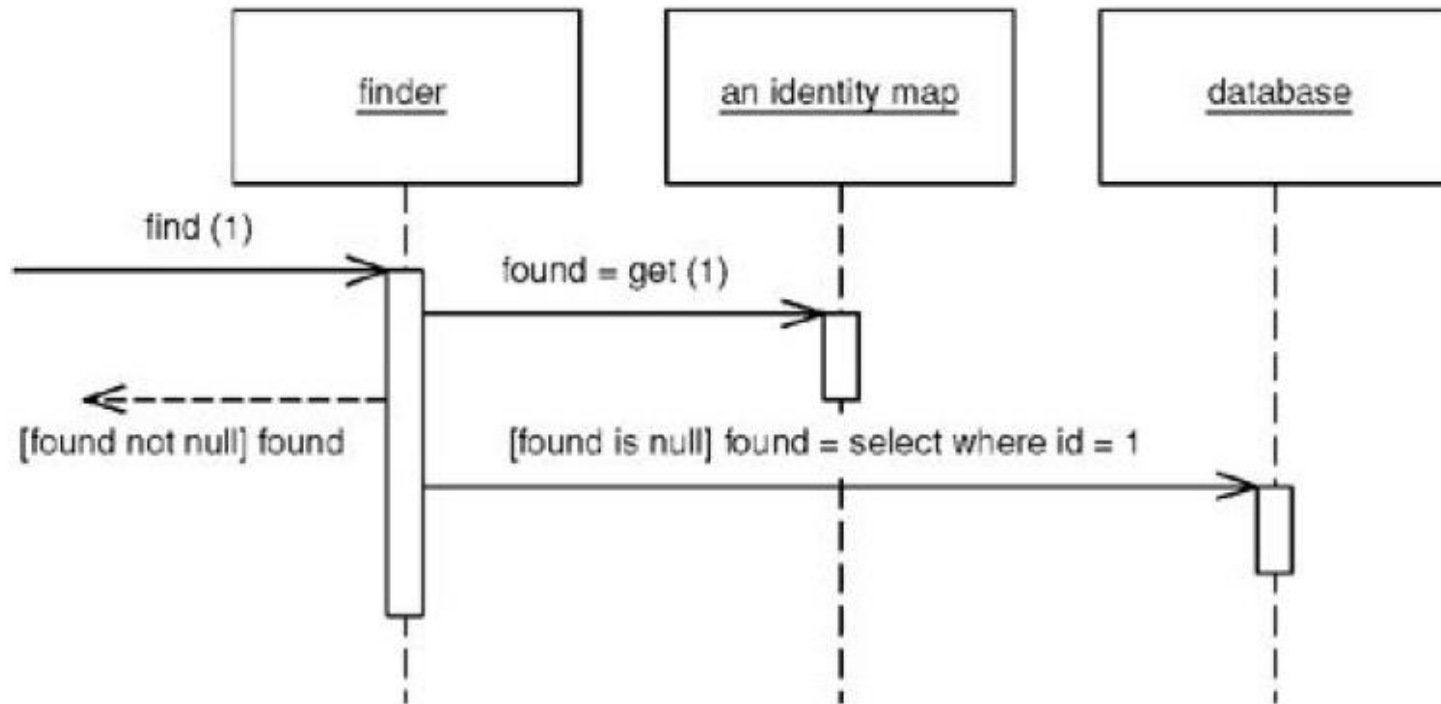

Creating an Identity Map

- ▶ One IdMap per database table
- ▶ The IdMap stores a private map
 - ▶ Key = field(s) of the Table that constitute the Primary Key
 - ▶ Value = Java Bean representing the table

```
class TableNameIdMap {  
    private Map<Key, TableName> map ; }  
}
```

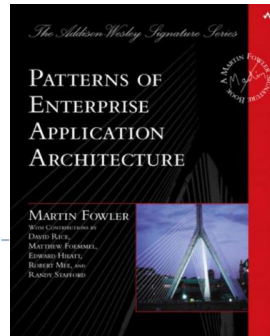

Using the Identity Map

- ▶ Create and store the IdMap in the Model
- ▶ Pass a reference to the IdMap to the DAO methods
- ▶ In the DAO, when loading an object from the database, first check the map
 - ▶ If there is a corresponding object, return it (and don't create a new one)
 - ▶ If there is no corresponding object, create a new object and put it into the map, for future reference
- ▶ If possible, check the map *before* doing the query

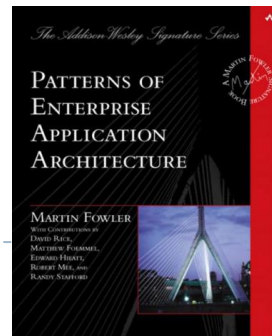



Connection pooling

Database access and JDBC

Connection pooling

- ▶ **Opening and closing DB connection is expensive**
 - ▶ Requires setting up TCP/IP connection, checking authorization, ...
 - ▶ After just 1-2 queries, the connection is dropped and all partial results are lost in the DBMS
- ▶ **Connection pool**
 - ▶ A set of “already open” database connections
 - ▶ DAO methods “lend” a connection for a short period, running queries
 - ▶ The connection is then returned to the pool (not closed!) and is ready for the next DAO needing it

JDBC 3.0 Connection pooling architecture

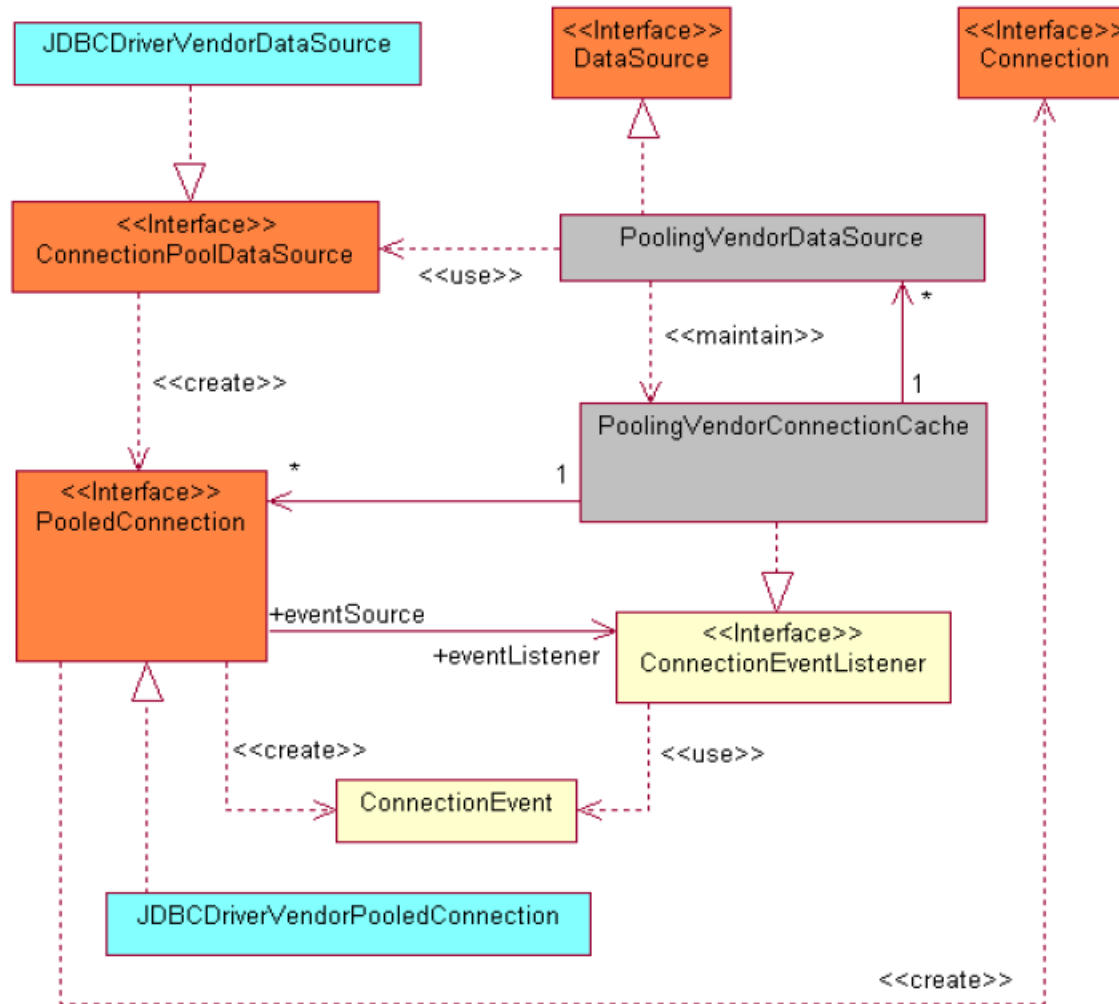

Benchmarks

	100 Iterations	100 Iterations	1000 Iterations	3000 Iterations
Pooling	547 ms	<10 ms	47 ms	31 ms ¹
Non-Pooling	4859 ms	4453 ms	43625 ms	134375 ms

The first time, the connections must be created

Second time, reuse connections

Negligible overhead

10x slower

No improvement

Linear increase

Connection Pooling libraries

光 = «Light», «Ray»



<https://brettwooldridge.github.io/HikariCP/>



c3p0 - JDBC3 Connection and Statement Pooling
version 0.9.5.4

<https://www.mchange.com/projects/c3p0/>

<https://translate.google.com/?client=firefox-b-d&um=1&ie=UTF-8&hl=en&client=tw-ob#ja/en/%E5%85%89>

HikariCP library for CP

- ▶ Open source library for adding connection pooling capabilities to JDBC drivers
 - ▶ <https://brettwooldridge.github.io/HikariCP>
 - ▶ <https://github.com/brettwooldridge/HikariCP>
- ▶ Connection Pooling
- ▶ Prepared Statement cache
 - ▶ Better at Driver level
 - ▶ <https://github.com/brettwooldridge/HikariCP/issues/488>
- ▶ Requirement: SLF4J (Simple Logging Facade for Java)
<https://www.slf4j.org/>

Detour: Logging

<https://www.slf4j.org/manual.html>

TdP Maven Archetype

- ▶ The Maven Archetype for TdP already includes the HikariCP library (and SLF4J dependency)... you don't need to download, install nor configure anything





Using HikariCP

```
import com.zaxxer.hikari.*;
...

HikariDataSource ds = new HikariDataSource();

ds.setJdbcUrl("jdbc:mysql://localhost:3306/simpsons");
ds.setUsername("bart");
ds.setPassword("51mp50n");

...

ds.getConnection();
```

<https://github.com/brettwooldridge/HikariCP#initialization>



Closing up

- ▶ To release a connection to the pool:
 - ▶ `connection.close();`
 - ▶ ...otherwise the pool will run out of available connections!
- ▶ To destroy the connection pool and clean up resources:
 - ▶ `ds.close();`
 - ▶ Also disconnects from database.
 - ▶ May be placed in a `stop()` method in the main JavaFX class
- ▶ **Alternatively**
 - ▶ `DataSources.destroy(ds);`

References

▶ JDBC Basics: Tutorial

- ▶ <http://docs.oracle.com/javase/tutorial/jdbc/TOC.html>
- ▶ <http://pdf.coreservlets.com/Accessing-Databases-JDBC.pdf>

▶ More advanced tutorials

- ▶ https://www3.ntu.edu.sg/home/ehchua/programming/java/JDBC_Intermediate.html

▶ JDBC reference guide

- ▶ <http://docs.oracle.com/javase/6/docs/technotes/guides/jdbc/getstart/GettingStartedTOC.fm.html>

▶ JDBC JavaDoc

- ▶ <http://docs.oracle.com/javase/6/docs/api/java/sql/package-summary.html>
- ▶ <http://docs.oracle.com/javase/6/docs/api/javax/sql/package-summary.html>

References

- ▶ Comparison of different SQL implementations
 - ▶ <http://troels.arvin.dk/db/rdbms/>
 - ▶ essential!
- ▶ DAO pattern
 - ▶ <http://www.oracle.com/technetwork/java/dataaccessobject-138824.html>
 - ▶ <http://www.corej2eepatterns.com/Patterns2ndEd/DataAccessObject.htm>
 - ▶ http://en.wikipedia.org/wiki/Data_Access_Object
 - ▶ <http://balusc.blogspot.it/2008/07/dao-tutorial-data-layer.html>

References

- ▶ **ORM patterns and Identity Map**
 - ▶ Patterns of Enterprise Application Architecture, By Martin Fowler, David Rice, Matthew Foemmel, Edward Hieatt, Robert Mee, Randy Stafford, Addison Wesley, 2002, ISBN 0-321-12742-0

References

▶ Connection pooling

▶ Introduction:

<http://www.datadirect.com/resources/jdbc/connection-pooling/index.html>

▶ with MySQL Connector/J: http://dev.mysql.com/tech-resources/articles/connection_pooling_with_connectorj.html





▶ <http://dev.mysql.com/doc/refman/5.5/en/connector-j-usagenotes-j2ee.html#connector-j-usagenotes-tomcat>

▶ Tomcat tutorial: <http://tomcat.apache.org/tomcat-5.5-doc/jndi-resources-howto.html#JDBC%20Data%20Sources>

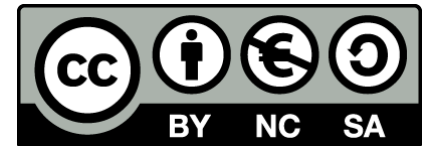
▶ HikariCP: A solid high-performance JDBC connection pool at last <https://github.com/brettwooldridge/HikariCP>

Licenza d'uso



- ▶ Queste diapositive sono distribuite con licenza Creative Commons “Attribuzione - Non commerciale - Condividi allo stesso modo (CC BY-NC-SA)”
- ▶ Sei libero:
 - ▶ di riprodurre, distribuire, comunicare al pubblico, esporre in pubblico, rappresentare, eseguire e recitare quest'opera 
 - ▶ di modificare quest'opera 
- ▶ Alle seguenti condizioni:
 - ▶ **Attribuzione** — Devi attribuire la paternità dell'opera agli autori originali e in modo tale da non suggerire che essi avallino te o il modo in cui tu usi l'opera. 
 - ▶ **Non commerciale** — Non puoi usare quest'opera per fini commerciali. 
 - ▶ **Condividi allo stesso modo** — Se alteri o trasformi quest'opera, o se la usi per crearne un'altra, puoi distribuire l'opera risultante solo con una licenza identica o equivalente a questa. 
- ▶ <http://creativecommons.org/licenses/by-nc-sa/3.0/>